

Plug AM-TOP® - Part no. 264

- screw terminals
- single part body
- cable gland and sealing
- strain relief and protection against kinking

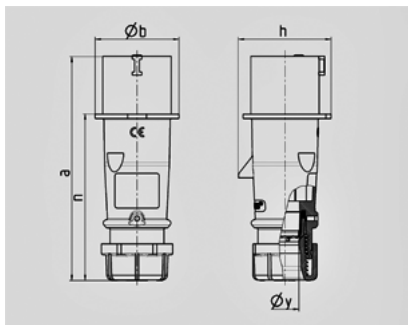

Technical information	
Ampere	32 A
Poles	4 p
Voltage	400V
Earth position	6 h
Hertz	50-60 Hz
Connection technology	Screw terminals
Contact	standard
Protection type	IP 44



Drawing 2 MB 217	Amp. Poles	16			32		
		3	4	5	3	4	5
Dim. in mm	a	142	147	147	186	186	180
	b	53	59	67	70	70	77
	h	59	69,4	76	81	81	89,5
	n	105,2	110,5	110,5	141	141	135
	y	14,5	16	16	22	22	22
Terminal for cond. cross		1	1	1	2,5	2,5	2,5
section (mm²) min.-max.		—2,5	—2,5	—2,5	—6	—6	—6